

KAF/DC cable fixing plate

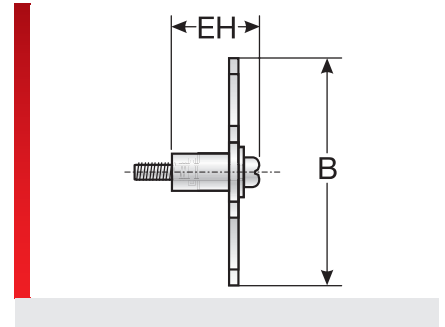
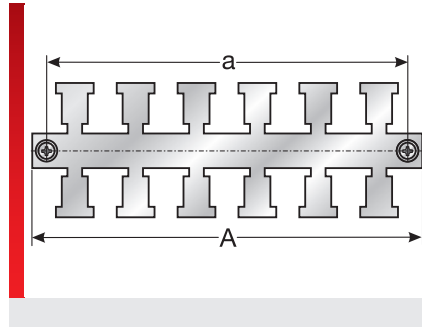
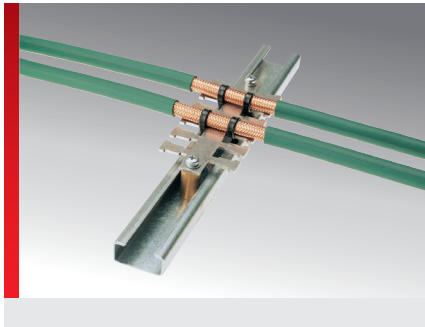

EMC solutions

PRODUCT INFORMATION

The cable fixing plate KAF/DC is suitable for discharging interferences which may occur on cable sheaths. The ground connection occurs via the fixing screws. The version DC is only suitable for direct installation on a conductive background. Stripping the cable in the area of the cable fixing plate and

fastening by means of cable ties ensures contact to the cable fixing plate. A low-resistance ground contact is achieved by mounting the KAF on the mounting plate. The use of two connecting points ensures a good discharge regardless of the position of the cable on the KAF.

SPECIFICATIONS

Plate: V2A
 Stand: Brass

Type	Order No.	Quantity of cables	Installation height mm	A mm	B mm	c mm	Pack qty.
KAF/DC-83 EMV	87201252	4	26.50	83.00	49.00	70.00	1

MATERIAL PROPERTIES

Plate: V2A
 Stand: Brass

FIRE PROPERTIES

APPROVALS AND OPERATING PERMITS

GL approval

All details given in our sales brochures and catalogues, as well as the information available online, are based on our current knowledge of the products described.

The electronic data and files made available by Murrplastik, particularly CAD files are based on our current knowledge of the product described.

A legally binding assurance of certain properties or the suitability for a certain purpose can not be determined from this information.

All information with respect to the chemical and physical properties of Murrplastik products, as well as application advice given verbally, in writing or by tests, is given to the best of our knowledge.

This does not free the purchaser of carrying out their own inspections and tests in order to determine the suitability of a product for a specific purpose.

Murrplastik accepts no responsibility for the available information being up-to-date, correct or complete. Neither do we accept responsibility for the quality of this information.

Murrplastik accepts no liability for damage caused as a result of using our products.

Murrplastik reserves the right to make technical changes and improvements through constant further development of products and services.

Our General Terms and Conditions apply.